



DATA SHEET

SGC 120/121

Single Genset Controllers



1. Product description	
1.1 Controller description.....	3
1.2 Product overview.....	3
1.3 Overview of controller buttons.....	4
2. Safety instructions	
2.1 General safety instructions.....	5
2.2 Electrical safety.....	5
2.3 In operation safety.....	5
3. Alarms	
3.1 Alarms.....	6
4. Technical specifications	
4.1 Electrical specifications.....	9
4.1.1 Power supply.....	9
4.1.2 Genset voltage and frequency measurements.....	9
4.1.3 Genset current measurements.....	10
4.1.4 Mains voltage and frequency measurement.....	10
4.1.5 Digital inputs.....	10
4.1.6 Analogue resistive sensor inputs.....	11
4.1.7 Analogue inputs used as digital inputs.....	12
4.1.8 Analogue voltage/current input.....	12
4.1.9 Magnetic pick-up (MPU) input.....	12
4.1.10 D+ Charger alternator.....	13
4.1.11 Sensor common point.....	13
4.1.12 Communication ports.....	13
4.1.13 Digital outputs.....	14
4.1.14 Rotary actuator outputs (SGC 121 only).....	14
4.2 Environmental specifications.....	14
4.3 Terminal details.....	15
4.4 Approvals.....	16
4.5 Dimensions.....	17
5. Legal information	
5.1 Legal information.....	18

1. Product description

1.1 Controller description

SGC 120/121 are modern genset controllers with user friendly HMI and full graphics LCD. The controllers come with a highly versatile software. Extensive inputs and outputs support a wide variety of industry standard features in diesel/gasoline genset applications.

SGC 121 includes electronic governing for engines with mechanical fuel systems. With a rotary actuator as add-on for air/fuel charge control, SGC 121 can perform electronic governing of the engine within ISO 8528 class G3 limits.

The DEIF Smart Connect software offers flexibility to configure each individual input and output for a specific function or application. All parameters can also be configured on the genset controller.

1.2 Product overview

Following table gives a brief overview of SGC 120/121 features:

Features	Specifications
Digital switch input	5
Analogue resistive inputs	3
Analogue current/voltage input	1
Mains voltage input (AMF)	Yes
DG alternator voltage input, D+ charging alternator I/O	Yes
DG alternator current input	Yes
Engine speed input via MPU	Yes
Digital outputs	6
Real Time Clock for event logs and Auto exercise mode	Yes
USB I/O port for laptop access	Yes
EEPROM for extended event logs OR regional languages	Yes
CANbus Engine Interface	Yes
RS-485 Interface for Modbus	Yes
DC battery supply voltage (with -32 V reverse protection)	8 to 28 V
Operating temperature range	-20 to 65 °C
Protection class with gasket (included)	IP65
Warning auto clear enable/disable	Yes
Fuel reference selection input	Yes
On the fly mode change when engine is healthy/engine off	Yes
Analogue 0-5 V input for Speed bias input for E-gov from Load sharing module	Yes*
E-gov actuator output	Yes*

*Note: SGC 121 only.

1.3 Overview of controller buttons

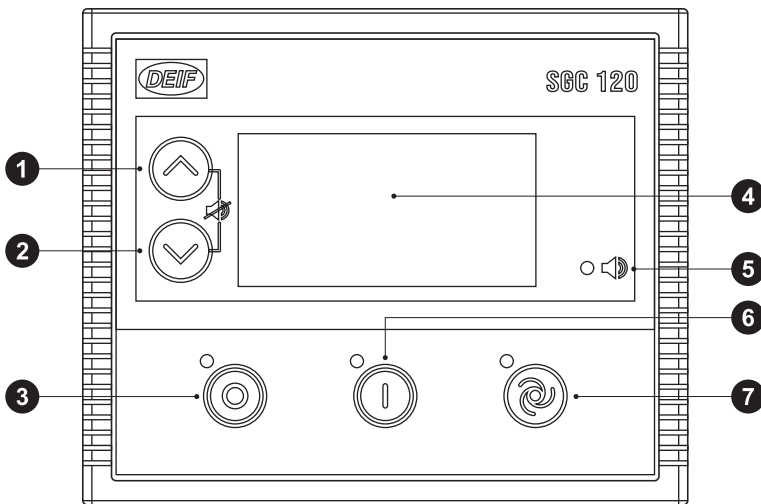

1. Menu navigation up button
2. Menu navigation down button
3. Stop/Config button
4. Display
5. Alarm LED
6. Start button
7. Mode selection button

Button functions

In Mode	Button input	Function
Manual	Start	Starts the engine
Manual	Auto	Enters Auto mode
	Stop	Stops the engine
	Stop (long press)	Enters Configuration mode
	Down + Stop (long press)	Enters Programming mode
Auto	Stop	Stops the engine and enters Manual mode
Manual Auto Configuration	Up Down	Scrolls through the views/parameters
Manual Auto	Up + Down (during Alarm view)	Acknowledges and clears the alarm
Configuration	Start	Selects/saves the parameter
Configuration	Up + Down (long press)	Enters the Event log page
Configuration	Stop (long press)	Back to Manual mode
Deep sleep	Any Key (for min. 1 s)	Back to Manual mode
Event log	Up + Down (long press)	Back to Configuration mode
Programming	Up + Down (long press)	Enters Manual mode

2. Safety instructions

2.1 General safety instructions

This document includes important instructions that should be followed during installation and maintenance of the controller.

Installation and maintenance must only be carried out by authorised personnel, and always in accordance with all applicable state and local electrical codes. Efficient and safe operation of the controller can be acquired only if the equipment is correctly operated, configured and maintained.

The following notations found in this document can indicate potentially hazardous conditions to the operator, service personnel or the equipment.

NOTE Highlights an essential element of a procedure to ensure correctness.



CAUTION

Indicates a procedure or practice, which could result in damage or destruction of equipment, if not strictly observed.



WARNING

Indicates a procedure or practice, which could result in injuring personnel or loss of life, if not followed correctly.

2.2 Electrical safety

- Electric shock can cause severe personal injury or death.
- Ensure that the genset is grounded before performing any installation or service.
- Generators produce high electrical voltages, and direct contact with it can cause fatal electrical shock. Prevent contact with terminals, bare wires, connections, etc., while the generator and related equipment are running. Do not tamper with interlocks.
- To handle the maximum electrical current, the wires used for electrical connections and wirings must be of appropriate size.

2.3 In operation safety

- Before installing the controller, ensure that all power voltage supplies are positively turned off at the source. Disconnect the generator's battery cables and remove the panel fuse to prevent accidental start up. Disconnect the cable from the battery post, indicated by a NEGATIVE, NEG, or (–) first. Reconnect the negative cable last. Failure to do so will result in hazardous and possibly fatal electrical shock.
- Remove the electric power supply before removing the controller or touching other electrical parts.
- Use extreme caution when working on electrical components. High voltage can cause injury or death.
- With floors of metal or concrete, use rubber insulation mats placed on dry wood platforms when working near the generator or other electrical equipment.
- Do not wear damp clothing (particularly wet shoes) or allow skin surface to be damp when handling electrical equipment.
- Do not operate any electrical device or wires while standing in water, while barefoot, or while hands or feet are wet. It may result in severe electrical shock.
- Do not wear jewellery. Jewellery can cause a short circuit within electrical contacts and cause shock or burning.

In case of an accident caused by electric shock, immediately shut down the electrical power source. If this is not possible, try to release the victim from the live conductor. Avoid direct contact with the victim. Use a non-conducting object (for example a rope or a wooden stick) to release the victim from the live conductor. If the victim is unconscious, apply first aid and get immediate medical help.

3. Alarms

3.1 Alarms

With SGC 120/121 it is possible to configure several Shutdown/Electrical trip, Warning and Notification alarms, for example Low oil pressure shutdown, Overload warning, and more.

An alarm occurs when the pre-configured parameter is out of preset level. The Alarm LED flashes and the Sounder alarm activates (if configured). The controller shows the alarm names on the Alarms display and the nature of alarm on Engine status display.

To acknowledge the alarms, press the *Up*  and *Down*  buttons simultaneously.

All alarms are activated from Engine ON, for example after crank disconnect, or Monitoring ON, for example after the Safety monitoring timer expires, or Always. The controller does not send the start command if Warning, Electrical trip or Shutdown alarms are left unacknowledged.

Alarm types

No.	Alarm actions	Description
1	Shutdown	Load is taken off from the genset and the genset is immediately stopped by skipping the Engine cooling time.
2	Electrical trip	Load is taken off from the genset, the Engine cooling timer begins, after which the genset is stopped.
3	Warning	Warning alarms draw the operator's attention to an undesirable condition without affecting the genset's operation. The genset cannot be started without acknowledging the Warning alarms
4	Notification	The controller shows the message on the display. The genset start/stop operation is not affected.

Alarms and their causes

No.	Alarms	Causes/Indication	Actions
1	Low Oil Pressure (Sensor)	Indicates that the oil pressure measured is below the preset threshold.	Shutdown Warning
	Low Oil Pressure (Switch)	Indicates that the oil pressure measured is low through switch.	Shutdown Warning Electrical Trip Notification
2	High Oil Pressure (Sensor)	Indicates that the oil pressure measured is above the preset threshold.	Warning
	High Oil Pressure (Switch)	Indicates that the oil pressure measured is high through switch.	Warning
3	High Eng Temp (sensor)	Indicates that the engine temperature is above the preset threshold. This condition is detected only when engine is on.	Shutdown Warning
	High Eng Temp (Switch)	Indicates that the engine temperature measured is high through switch.	Shutdown Warning Electrical Trip Notification

No.	Alarms	Causes/Indication	Actions
4	Low Fuel level (Sensor)	Indicates that the amount of fuel level is below the preset threshold. This condition is detected only when engine is on.	Shutdown Warning
	Low Fuel level (Switch)	Indicates that the amount of fuel level measured is low through switch.	Shutdown Warning Electrical Trip Notification
5	Low Water Level (Switch)	Indicates that radiator water level is below the preset threshold.	Shutdown Warning Electrical Trip Notification
6	Auxiliary input/User defined name	Configured auxiliary input has triggered longer than preset duration.	Shutdown Warning Electrical Trip Notification
7	Anlg LOP Ckt Open	The oil pressure sensor is not detected (circuit open).	Shutdown Warning Electrical Trip Notification
8	Engine Temp Ckt Open	The temperature sensor is not detected (circuit open).	Shutdown Warning Electrical Trip Notification
9	Fuel Level Ckt Open	The fuel level sensor is not detected (circuit open).	Shutdown Warning Electrical Trip Notification
10	Fuel Theft	The fuel consumption has exceeded the preset threshold.	Warning
11	Emergency Stop	Configured as digital input has triggered longer than preset or when an immediate shutdown is required.	Shutdown
12	Fail To Stop	It is detected that genset is still running after sending stop command.	Shutdown
13	Fail To Start	Indicates that genset has not started after the preset number of start attempts.	Shutdown
14	L1 Phase Over Voltage	Indicates that genset (L1) phase voltage has exceeded the preset over-voltage threshold.	Shutdown Warning
15	L2 Phase Over Voltage	Indicates that genset (L2) phase voltage has exceeded the preset over-voltage threshold.	Shutdown Warning
16	L3 Phase Over Voltage	Indicates that genset (L3) phase voltage has exceeded the preset over-voltage threshold.	Shutdown Warning
17	L1 Phase Under Voltage	Indicates that genset (L1) phase voltage has fallen below preset under-voltage threshold.	Shutdown Warning
18	L2 Phase Under Voltage	Indicates that genset (L2) phase voltage has fallen below preset under-voltage threshold.	Shutdown Warning
19	L3 Phase Under Voltage	Indicates that genset (L3) phase voltage has fallen below preset under-voltage threshold.	Shutdown Warning
20	DG Phase Reversal	Alternator phase sequence (L1-L2-L3) is not correct.	Shutdown Warning Electrical Trip Notification

No.	Alarms	Causes/Indication	Actions
21	Over Frequency	Indicates that genset output frequency has exceeded the preset threshold.	Shutdown Warning
22	Under Frequency	Indicates that genset output frequency has fallen below the preset threshold.	Shutdown Warning
23	Over Current	Indicates that genset current has exceeded the preset threshold.	Shutdown Warning Electrical Trip Notification
24	Over Load	Indicates that the measured kW load rating has exceeded the preset threshold.	Shutdown Warning Electrical Trip Notification
25	Unbalanced Load	Load on any phase is greater or less than other phases by a threshold value.	Shutdown Warning Electrical Trip Notification
26	Over Speed	Indicates that genset speed has exceeded the preset overspeed threshold. The genset will shut down after Overspeed delay.	Shutdown
27	Gross Over Speed	Indicates that genset speed has exceeded the preset Gross overspeed threshold. The genset will shut down immediately without any delay.	Shutdown
28	Under Speed	The engine speed has fallen below the preset RPM.	Shutdown
29	Extended Over Load Trip	Indicates that there was 100 % load on the genset for one hour in the time interval of 12 hours.	Electrical trip
30	Charge Fail	The charge alternator voltage has dropped below the preset threshold.	Shutdown Warning Electrical Trip Notification
31	V-Belt Broken Switch	Indicates that there is a failure of the V-belt, which is driving the charging alternator.	Shutdown Warning Electrical Trip Notification
32	Battery Under Voltage	The battery voltage has fallen below the preset threshold.	Shutdown Warning Electrical Trip Notification
33	Battery Over Voltage	The battery voltage has exceeded the preset threshold.	Shutdown Warning Electrical Trip Notification
34	Filter maintenance	Indicates that engine running hours has exceeded the preset hours limit or maintenance due date has occurred and filter servicing is required.	Warning Notification
35	Mains Phase Reversal	Indicates the mains unhealthy condition.	Notification

4. Technical specifications

4.1 Electrical specifications

4.1.1 Power supply

Category	Specification
Controller terminals	1 (Ground) 2 (Battery or DC+)
Supply voltage range	Nominal voltage: 12/24 V DC Operating range: 8 to 28 V DC
Cranking drop out period	50 ms
Maximum reverse voltage protection	-32 V DC
Measurement accuracy (battery voltage)	±1 % full scale
Resolution	0.1 V
Maximum current consumption	~ 200 mA, 12/24 V DC (excluding the current load for the DC and rotary actuator's outputs)
Standby current consumption LCD backlight off)	124 mA, 12 V DC 123 mA, 24 V DC
Deep sleep current	20 mA, 12/24 V DC

4.1.2 Genset voltage and frequency measurements

Category	Specifications
Controller terminals	27 (Neutral) 28 (L3) 29 (L2) 30 (L1)
Measurement type	True RMS
Phase-to-neutral voltage	32 to 300 V AC RMS
Phase-to-phase voltage	32 to 520 V AC RMS
Voltage accuracy	±1 % of full scale for phase-to-neutral ±2 % of full scale for phase-to-phase
Voltage resolution	1 V AC RMS for phase-to-neutral 2 V AC RMS for phase-to-phase
Frequency range	5 to 75 Hz
Frequency accuracy	0.25 % of full scale
Frequency resolution	0.1 Hz

NOTE For single phase applications, it is mandatory to connect the genset phase and neutral cables to the genset controller's phase L1 and neutral terminals.

4.1.3 Genset current measurements

Category	Specifications
Controller terminals	39 and 40 (for phase L1) 37 and 38 (for phase L2) 35 and 36 (for phase L3)
Measurement type	True RMS
Maximum CT secondary current rating	Nominal: -/5 A CT
Burden	0.25 VA
Measurement accuracy	±1.4 % of nominal

NOTE Follow the recommended phase sequence while connecting the current transformer (CT)

4.1.4 Mains voltage and frequency measurement

Category	Specifications
Controller terminals	31 (Neutral) 32 (L3) 33 (L2) 34 (L1)
Measurement type	True RMS
Phase-to-neutral voltage	32 to 300 V AC RMS
Phase-to-phase voltage	32 to 520 V AC RMS
Voltage accuracy	±2 % of full scale for phase-to-neutral ±2.5 % of full scale for phase-to-phase
Voltage resolution	1 V AC RMS for phase-to-neutral 2 V AC RMS for phase-to-phase
Frequency range	5 to 75 Hz
Frequency accuracy	0.25 % of full scale
Frequency resolution	0.1 Hz

NOTE For single phase applications, it is mandatory to connect the mains phase and neutral cables to the genset controller's phase L1 and neutral terminals.

4.1.5 Digital inputs

Category	Specifications
Controller terminals	10, 11, 12, 21, 22
Number of inputs	5
Type	Negative sensing (connect to ground for activation)
Software configurable options	Low Lub Oil Pressure (LLOP) Switch, High Water Temperature, and more (see Controller overview, Configurable parameters in the User manual for more details).

4.1.6 Analogue resistive sensor inputs

Category	Specifications
Controller terminals	24 (Engine temperature) 25 (Fuel level sensor) 26 (Oil pressure)
Number of inputs	3
Type	Ratio-metric sensing
Range	10 to 5000 Ω (terminal 24) 10 to 1000 Ω (terminal 25 and 26)
Open circuit detection	Above 1.5 k Ω (terminal 24) Above 5.5 k Ω (terminal 25 and 26)
Measurement accuracy	± 2 % of full scale (up to 1000 Ω)
Connection method	Connect the sensor output terminals between the genset controller terminal and the battery ground terminal

SCP connection

SCP connections for Analogue inputs 1 to 4*:

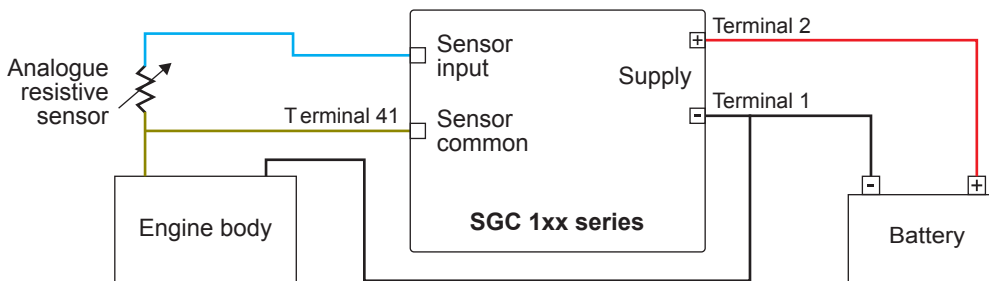

*SCP connections for Analogue input 2 used as *Fuel level sensor* with the reference configured as *Battery Negative*

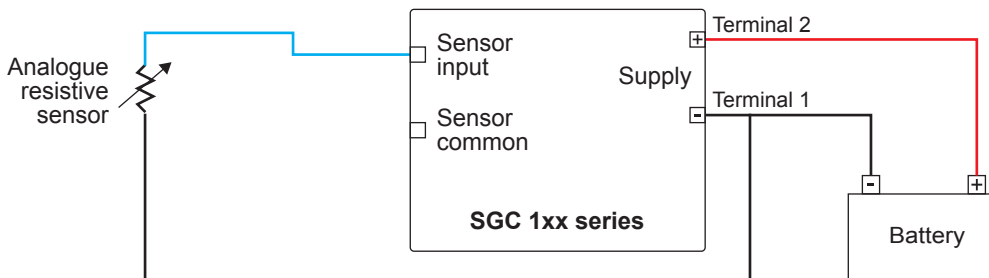

4.1.7 Analogue inputs used as digital inputs

Analogue inputs can be used as digital inputs when wired as shown.

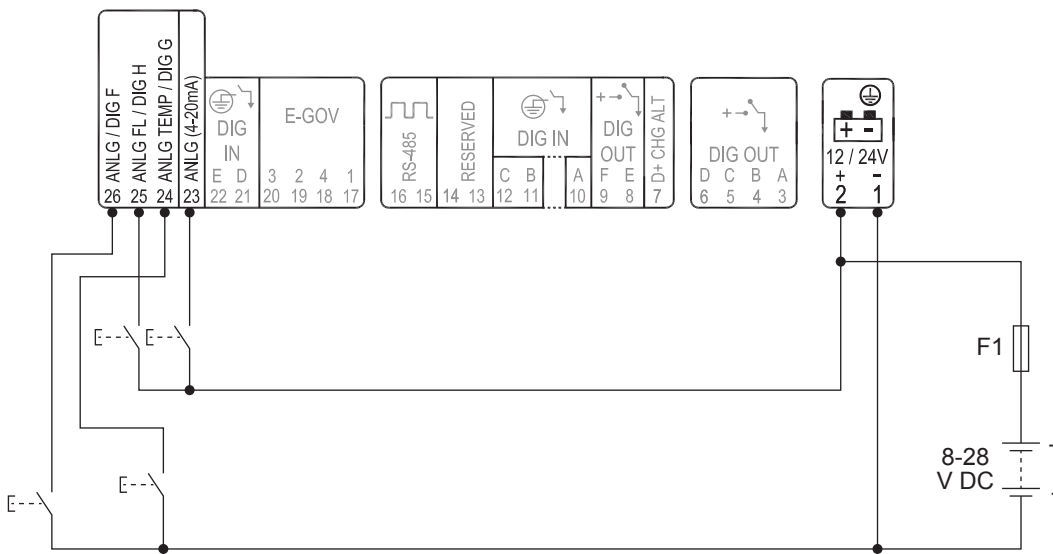

4.1.8 Analogue voltage/current input

Category	Specifications
Controller terminal	23
Measurement type	Analogue voltage/current sensing
Range	0 to 5 V DC 4 to 20 mA
Accuracy	±2 % of full scale voltage ±1.25 % of full scale current
Resolution	0.1 V 0.1 mA

4.1.9 Magnetic pick-up (MPU) input

Category	Specifications
Controller terminal	42
Measurement type	Single ended
Frequency range	10 to 10 kHz
Input voltage range	200 mV to 45 V AC RMS

The Magnetic pick-up (MPU) is an inductive sensor fitted on the engine flywheel for the engine speed sensing. The output of the MPU is a sine-wave signal.

4.1.10 D+ Charger alternator

Category	Specifications
Controller terminal	7
Voltage range	0 to V_{BATT} $V_{BATT} = 8$ to 28 V DC
Excitation	PWM (power limited to 3 W, 12 V/250 mA)
Accuracy	± 1 % of full scale

The charge fail is a combined input and output terminal. When the genset starts, the terminal provides controlled power output to excite the charging alternator. After the excitation is successfully done, the controller reads the charging alternator's output voltage for monitoring its health. The action for charge fail is configurable.

4.1.11 Sensor common point

Category	Specifications
Controller terminal	41
Range	± 2 V
Accuracy	± 2 % of full scale

NOTE The sensor common point (SCP) terminal 41 of the controller should be directly connected to an electrically sound point on the engine body. This point on the engine body should serve as a common reference point for all analogue sensors such as those for measuring lube oil pressure, engine temperature and fuel level. The electrical cable used for the connection should not be shared with any other electrical connection. Such a wiring practice is strongly recommended to ensure that there is negligible potential difference, if any, between the engine body and the controller's SCP terminal, and, predictable and accurate analogue sensor measurements are always available in a wide variety of field conditions.

4.1.12 Communication ports

Category	Specifications
USB	USB 2.0 type B for connection to PC with DEIF Smart Connect software.
RS-485 Serial Port	Half Duplex Max. Baud Rate 115200 Data connection 2-wire Termination resistor of 120 Ω between output terminals A and B (internally mounted) Common mode operating range and bus pin fault protection up to ± 70 V Maximum distance of line is 200 m
Controller terminals for RS-485	15 and 16
CAN (SGC 120 only)	Baud rate: 250 kbps Packet size: 8 bytes Termination resistor of 120 Ω is provided
Controller terminals for CAN (SGC 120 only)	13 and 14

4.1.13 Digital outputs

Category	Specifications
Controller terminals	3, 4, 5, 6, 8, 9
Number of outputs	6
Type	DC outputs
Maximum current rating	Max. per output: 500 mA Total max.: 1 A
Software configurable options	Start relay, Fuel relay and many more (see Controller overview , Configurable parameters for more details).

- NOTE**
- Do not connect the starter motor relay and the stop solenoid directly to the controller's output terminals.
 - Genset and mains contactor latching relays should be compiled against 4 kVA surge as per IEC-61000-4-5 standard.

4.1.14 Rotary actuator outputs (SGC 121 only)

Category	Specifications
Controller terminal	17, 18, 19 and 20
Type	Stepper motor drive
Max. current	1 A

The actuator outputs are used only for the Rotary actuator, if installed. The Rotary actuator is a 4-wire actuator that is used for creating an electronic governing application in case of a mechanical fuel system engine. In diesel engines, the Rotary actuator's shaft output gets mechanically connected to the stop lever or the throttle lever of an in-line or rotary fuel injection pump. In case of petrol or natural gas engines, the Rotary actuator's shaft output gets connected to the throttle/charge control valve.

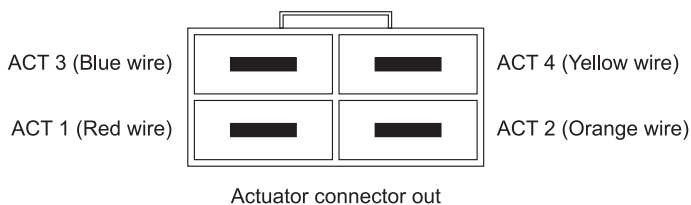

It is recommended to follow the connection details of the Rotary actuator connector and SGC 121.

4.2 Environmental specifications

Operation conditions	
Operating temperature	-20 to +65 °C (-4 to +149 °F), in compliance with IEC 60068-2-1, 2
Storage temperature	-30 to +75 °C (-22 to +167 °F), in compliance with IEC 60068-2-1, 2
Vibration	2G in X, Y and Z axes for 8 to 500 Hz, in compliance with IEC 60068-2-6
Shock	15 g for 11 ms, in compliance with IEC 60068-2-27
Humidity	0 to 95 % RH, in compliance with IEC 60068-2-78
Protection degree	IP65 for front face with gasket, in compliance with IEC 60529
EMI/EMC	In compliance with IEC 61000-6-2, 4

4.3 Terminal details

Rear view of the controllers with terminal details.

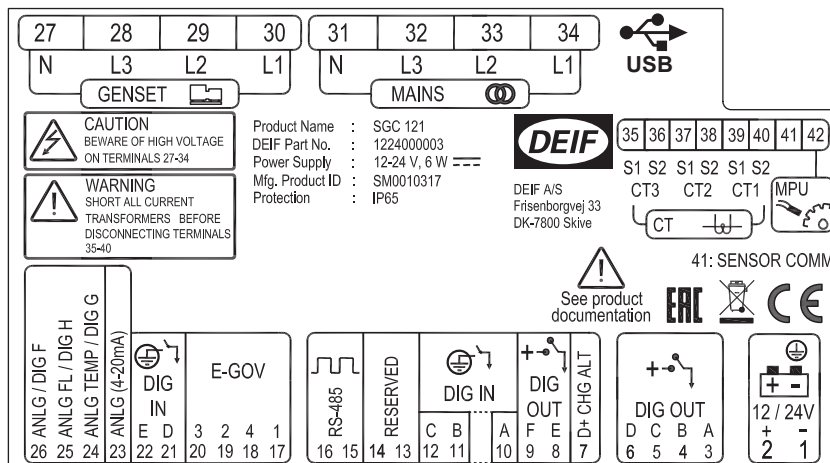

Terminal	Text	Description	Phoenix connector
1	GND	Power ground	5441980
2	BATT +	Power supply positive	
3	DIG OUT A	DC output - A	
4	DIG OUT B	DC output - B	5441430
5	DIG OUT C	DC output - C	
6	DIG OUT D	DC output - D	
7	D+ CHG ALT	Input for charging alternator control	
8	DIG OUT E	DC output - E	5441223
9	DIG OUT F	DC output - F	
10	DIG IN A	Input from switch A	
11	DIG IN B	Input from switch B	
12	DIG IN C	Input from switch C	
13	CAN H	CAN High	5441249
14	CAN L	CAN Low	
15	RS-485 B	RS-485 B	
16	RS-485 A	RS-485 A	

Terminal	Text	Description	Phoenix connector
17	GOV_ACT-OUT1	Output for actuator (SGC 121 only)	5447560
18	GOV_ACT-OUT4	Output for actuator (SGC 121 only)	
19	GOV_ACT-OUT2	Output for actuator (SGC 121 only)	
20	GOV_ACT-OUT3	Output for actuator (SGC 121 only)	
21	DIG_IN D	Input from switch D	
22	DIG_IN E	Input from switch E	
23	ANLG_I_IN (SGC 120)	Analogue input 4 to 20 mA	
	ANLG_IN (SGC 121)	Analogue input 4 to 20 mA/2.5 ±2 V	
24	ANLG_IN ENG_TEMP	Analogue input from Engine temperature sensor	
25	ANLG_IN FUEL_LEVEL	Analogue input from Fuel level sensor	
26	ANLG_IN LOP	Analogue input from Lube oil pressure sensor	
27	GEN_V-IN NTRL	Voltage input from Generator Neutral	5453499
28	GEN_V-IN L3	Voltage input from Generator phase L3	
29	GEN_V-IN L2	Voltage input from Generator phase L2	
30	GEN_V-IN L1	Voltage input from Generator phase L1	
31	MAINS_V-IN NTRL	Voltage input from Mains Neutral	
32	MAINS_V-IN L3	Voltage input from Mains phase L3	
33	MAINS_V-IN L2	Voltage input from Mains phase L2	
34	MAINS_V-IN L1	Voltage input from Mains phase L1	
35	GEN_CT-IN L3 1	CT input 1 from Generator phase L3	5441252
36	GEN_CT-IN L3 2	CT input 2 from Generator phase L3	
37	GEN_CT-IN L2 1	CT input 1 from Generator phase L2	
38	GEN_CT-IN L2 2	CT input 2 from Generator phase L2	
39	GEN_CT-IN L1 1	CT input 1 from Generator phase L1	
40	GEN_CT-IN L1 2	CT input 2 from Generator phase L1	
41	SCP	Sensor common point	
42	MPU-IN	MPU Input	

4.4 Approvals

Standards	
CE	<ul style="list-style-type: none"> Comply to the EU Low Voltage Directive: EN 61010-1 Safety requirements for electrical equipment for measurement, control, and laboratory use - Part 1: General requirements Comply to the EU EMC directive EN 61000-6-2, 4

4.5 Dimensions

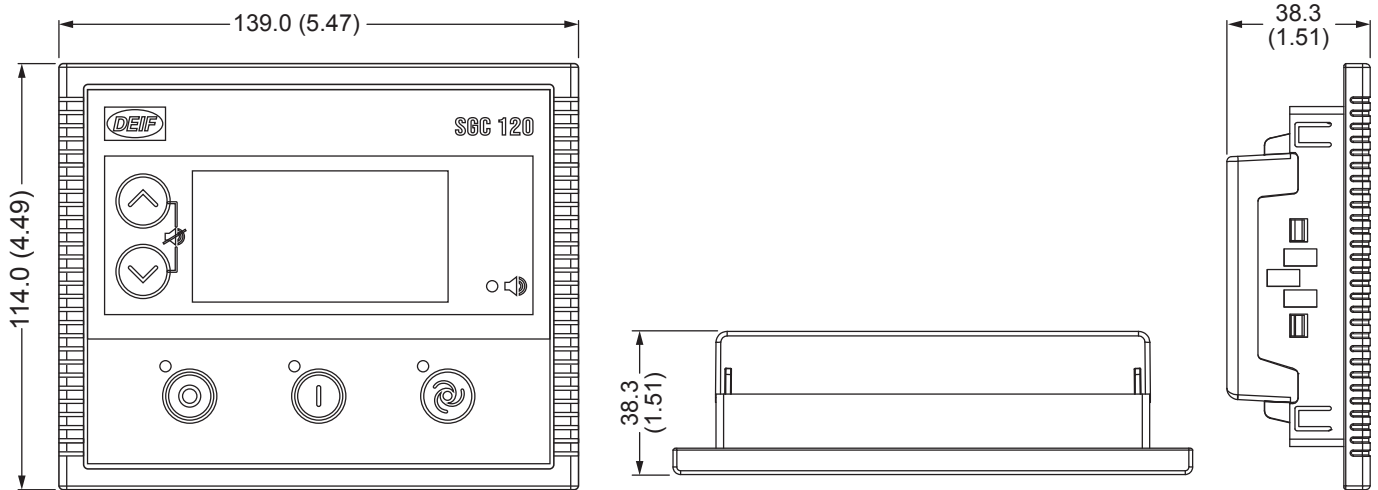

	Length	Height	Depth
Controller	139.0 mm (5.47 in)	114.0 mm (4.49 in)	38.3 mm (1.51 in)
Panel cut-out	118.0 mm (4.65 in)	93.0 mm (3.66 in)	Tolerance: ± 0.3 mm (0.01 in)

5. Legal information

5.1 Legal information

Warranty



WARNING

The controller is not to be opened by unauthorised personnel. If the controller is opened anyway, the warranty will be lost.

Disclaimer

DEIF takes no responsibility for installation or operation of the generator set. If there is any doubt about how to install or operate the engine/generator controlled by the SGC controller, the company responsible for the installation or the operation of the set must be contacted.

DEIF A/S reserves the right to change any of the contents of this document without prior notice.

The English version of this document always contains the most recent and up-to-date information about the product. DEIF does not take responsibility for the accuracy of translations, and translations might not be updated at the same time as the English document. If there is a discrepancy, the English version prevails.

Copyright

© Copyright DEIF A/S 2020. All rights reserved.